Micro inverter

User's Manual

V1.1

NBQ1600-EU

NBQ2000-EU

NBQ2250-EU

NBQ2400-EU

Statement:

Before using this product, please read this document carefully to ensure that you fully understand it and can use it properly. After reading this document, please keep it in a safe place for future reference.

Improper operation of this product may result in serious injury to yourself or others, or damage to this product and other property. By using this product you are deemed to have understood, acknowledged and accepted all the terms and conditions of this document. The Company shall not be liable for any damages resulting from the user's failure to operate this product in accordance with the instructions for use.

In accordance with laws and regulations, we reserve the right of final interpretation of this document and all documents related to this product. This document is subject to update without prior notice, please visit the official website for the latest version.

Catalogs

1. IMPORTANT NOTES	3
1.1 PRODUCT RANGE	3
1.2 DESCRIPTION OF SYMBOLS	3
2. SECURITY GUIDELINES	4
2.1 IMPORTANT SAFETY INSTRUCTIONS	4
2.2 ENVIRONMENTAL REQUIREMENTS	4
3. DELIVERY LIST	4
4. OVERVIEW	5
4.1 OVERVIEW OF GRID-CONNECTED PV INVERTER SYSTEMS	5
4.2 MICROINVERTER OVERVIEW	6
4.3 COMPATIBILITY	6
4.4 EXTERNAL DIMENSIONS (MM)	7
4.5 INTRODUCTION TO FUNCTIONS	7
4.6 SYSTEM MONITORING	7
5. INSTALLATION	8
5.1 INSTALLATION REQUIREMENTS	8
5.2 COMPONENTS AND TOOLS REQUIRED FOR INSTALLATION	9
5.3 INSTALLATION STEPS	9
6. APP	14
6.1 DOWNLOAD APP	14
6.2 REGISTERING AN ACCOUNT	14
6.3 CONNECTING THE MICROINVERTER	15
6.4 APP INTERFACE	16
7. TROUBLESHOOTING	17
7.1 LED STATUS INDICATION	17
7.2 APP ALARM INFORMATION	17
7.3 REPLACING THE MICROINVERTER	17
8. DATA SHEET	19
9. ANNEXES	21
9.1 ANNEX 1 INSTALLATION MAP	21
9.2 ANNEX 2 WIRING DIAGRAM	22

1. Important notes







1.1 Product Range

This manual describes the assembly, installation, commissioning, maintenance and troubleshooting of the following models of microinverters.

NBQ1600-EU NBQ2000-EU NBQ2250-EU NBQ2400-EU

**Note: "1600" means 1600 W, "2000" means 2000 W, "2250" means 2250 W, "2400" means 2400 W.*

1.2 Description of symbols

Notation	Clarification
	High voltage hazard High voltages in microinverters can be life-threatening.
	caveat Do not get within 8 inches (20 cm) of the microinverter while it is operating.
	Watch out for the heat. The inverter heats up during operation and should be operated in such a way as to avoid contact with metal surfaces.
	Disposal of equipment Electronic equipment should not be disposed of with household waste, and old, unusable appliances must be collected and disposed of separately, in accordance with local ordinances or regulations.
	CE mark The microinverters are labeled with the CE mark to certify that the device complies with the European Low Voltage and EMC Directives.
	Operating Instructions Please read the instruction manual carefully before using this product.
	earth (wire) The AC cable contains a ground wire and can therefore be grounded directly. For areas with special requirements, a grounding bracket is installed to complete the external grounding.
RoHS	RoHS symbol The product complies with 2011/65/EU & (EU) 2015/863.

2. safety norm

2.1 Important safety instructions

- ✧ Before installing, using, or servicing this product, please read all documentation carefully, which may have changed due to product updates or other reasons.
- ✧ All operations, including transportation, installation, start-up and maintenance, must be carried out by trained and qualified personnel.
- ✧ Prior to installation, check the packaging and appearance of the unit to ensure that it has not been damaged during transportation.
- ✧ Ensure that all cables and plugs are intact and dry before connecting to avoid electric shock.
- ✧ Before the end of the installation, make sure that the solar PV panels, microinverters are disconnected from the home power supply.
- ✧ Personal protective equipment such as gloves and goggles must be used during installation.
- ✧ Do not install or operate the equipment under extreme weather conditions, such as lightning, snow, heavy rain, strong winds, etc.
- ✧ Warning signs on the equipment must not be damaged, defaced or removed.
- ✧ After installation, remove any remnants of the installation, such as cut cable ties, torn insulation, etc.
- ✧ Do not attempt to repair the microinverter, if it fails, contact our customer support department and initiate the replacement process. Private repair or opening of the microinverter will void the warranty policy.
- ✧ Understand the components and functions of a grid-connected PV system and ensure that all electrical connections, as well as the voltage and frequency of the equipment, comply with local electrical standards.
- ✧ Use extreme caution whenever the inverter is disconnected from the utility grid, as certain components may retain enough charge to create a shock hazard.
- ✧ Ensure that the microinverter is mounted securely to prevent accidents or damage to the product from falling.
- ✧ For safety reasons, the device should use original or authorized cables, we are not responsible for damage to the device caused by the use of third-party accessories.

2.2 Environmental requirements

- ✧ Ensure that the equipment is installed, operated or stored in a well-ventilated area; inadequate ventilation can cause permanent damage to the equipment.
- ✧ Do not install or place this equipment in a strong electrical and magnetic field environment to avoid radio interference.
- ✧ Do not install the equipment in flammable, explosive, corrosive, extremely hot, cold and humid environments.
- ✧ Do not install the unit where children and pets can reach it.

3. Delivery list

1. Micro inverter *1
2. Power cord*1
3. User's Manual*1
4. M8 screw combination*2

Notes:

- ✧ Please contact customer service if any parts are missing.
- ✧ Other tools and accessories involved in installation and commissioning are not included in the packing list, if you need to use, please purchase separately.

4. summarize

4.1 Overview of grid-connected PV inverter systems

The grid-connected PV inverter system consists of PV modules, microinverters, meters and the grid. The microinverters convert the DC power generated by the PV modules into AC power that meets the requirements of the grid, and then the AC power is connected to the grid through the meter.

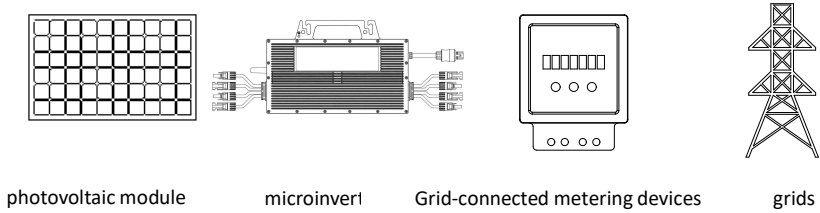

✧ Single Microinverter Connection Diagram

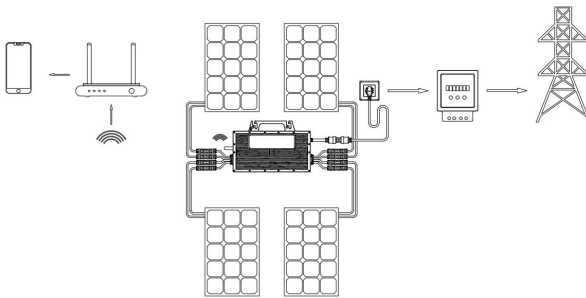

✧ Multiple Microinverter Connection Diagram

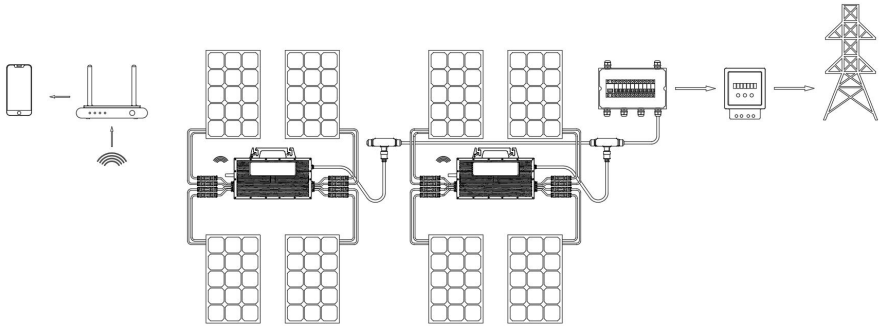

4.2 Microinverter Overview

- ✧ A microinverter is a module-level solar inverter that tracks the maximum power point of each PV module.
- ✧ When one PV module fails or is shaded, the other modules are not affected.
- ✧ The microinverter monitors the current, voltage and power of each module, enabling module-level data monitoring.
- ✧ Microinverters feature low voltage DC, eliminating the risk of exposing personnel to hazardous high voltage DC.
- ✧ Microinverters are easy to install and can be varied according to the number of PV modules.
- ✧ The microinverter housing is designed for outdoor installation and complies with the IP67 protection rating.

4.3 compatibility

See the "Data Sheet" in this manual to verify the electrical compatibility of the PV modules, and be sure to order PV modules suitable for the microinverter from your dealer.

4.4 External dimensions (mm)

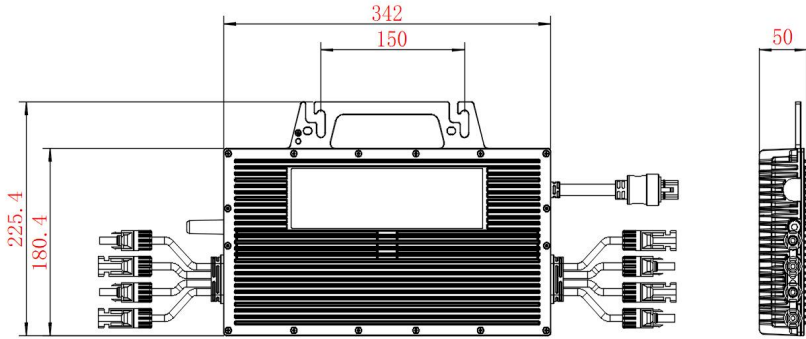

4.5 Function

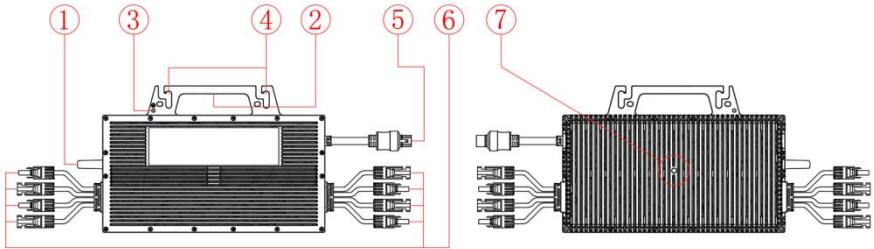

item (of program)	clarification
1	connection with high-ranking officials
2	grips
3	grounding hole
4	mounting hole
5	AC Output Connector
6	DC Input Connector
7	LED indicator

4.6 System monitoring

The microinverters are connected to the Internet through a broadband router, and after following the operating instructions to connect to the system platform, the platform will display current and historical

performance trends and inform the status of the PV system in real time.

5. mounting

5.1 Installation Requirements

The installation must disconnect the equipment from the grid and shade or isolate the PV modules.

The input PV cable should be less than 3 meters.

Ensure that the environmental conditions meet the requirements of the microinverter (protection class, temperature, humidity, altitude, etc.).

Avoid direct sunlight to prevent the internal temperature of the microinverter from rising and causing power reduction.

Keep the inverter away from gas or flammable materials.

Avoid electromagnetic interference as it can affect the normal operation of electronic equipment.

The stripes on the back of the microinverter are heat sinks, make sure that the heat sinks are at a distance of more than 20cm from other objects when installing and keep them ventilated.

Notes:

- ✧ If you want to check your solar system and put it into operation immediately, assemble it in sunny weather.
- ✧ We recommend that at least three people work together during assembly or disassembly.

5.2 Parts and tools required for installation



M8 screws*2



M8 nut*2



Ties*10

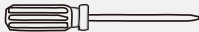

Screwdriver*1



Hexagonal Wrench*1

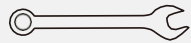

Wrench*1

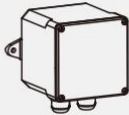

Junction box*1

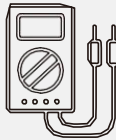

Voltmeter*1

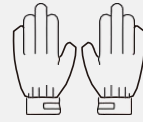

Protective Gloves*1

Notes:

- ✧ In addition to the equipment and accessories in the delivery list, other tools need to be prepared by yourself.

5.3 Installation steps

Installing a microinverter involves several key steps, each of which is described in detail below.

Step 1 - Planning and Installing the Microinverter

Step 2 - Layout of AC Cables

Step 3 - Microinverter Connection

Step 4 - Connecting the Junction Box

Step 5 - Create Installation Diagram

Step 6 - Connecting the PV Module

Step 7 - Powering Up the System

Step 8 - Setting up a monitoring system

Step 1 - Planning and Installing the Microinverter

- A) Mark the position of each microinverter on the rails according to the PV module layout.
- B) Secure the screws to the rail.
- C) Hang the microinverter on the screws and tighten the screws.



Figure A

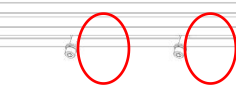

Figure B

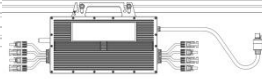
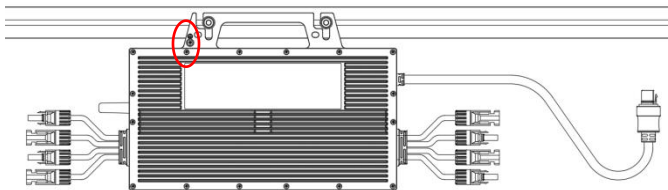

Figure C

*The microinverter shall be mounted below the PV module to avoid direct sunlight, rain, snow, UV rays, etc. The AC cable contains the ground wire and can be grounded directly, for areas with special requirements we provide a grounding bracket. A continuous ground cable is routed through the microinverter grounding bracket and connected to an electrode that meets local regulations to complete the grounding requirements.



Using a screwdriver, install the grounding bracket wire to the grounding hole on the top of the microinverter and tighten the screw to 2 N.m.

Step 2 - Layout of AC Cables

- A) Determine the number of microinverters to be installed on each AC branch and prepare the appropriate number of AC cables.
- B) Select the appropriate length of AC cable for the distance between the microinverters. Reserve extra length in advance for connecting, trapping and bending the cables.
- C) Lay the trunk AC cables on the rails and secure them briefly so that the microinverters can be connected to the trunk.

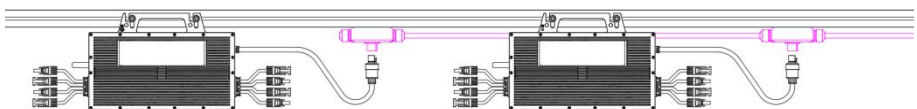

Step 3 - Parallel Microinverters

- A) Align the connector of the trunk AC cable with the AC output port on the right side of the microinverter until you hear a "click".
- B) Repeat the above to connect the microinverter to the same branch line.
- C) Use rolled tape to secure AC cables.

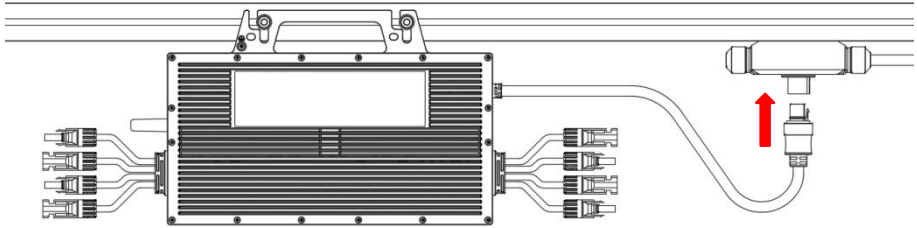

* The number of microinverters on the same branch line must not exceed the maximum number of connections specified.

Step 4 - Connecting the Junction Box

- A) The AC cable is connected to the microinverter AC output port.
- B) Connect the AC cable to an outlet or junction box.
 - a) Connect to the socket.
 - b) Connect to the junction box.

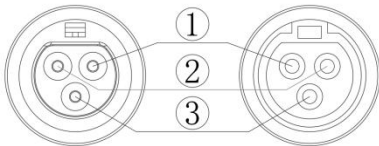

- ① ---L (line of fire)
- ② --- N (zero line)
- ③ ---PE (ground)

*Interfaces and wires used for microinverters.

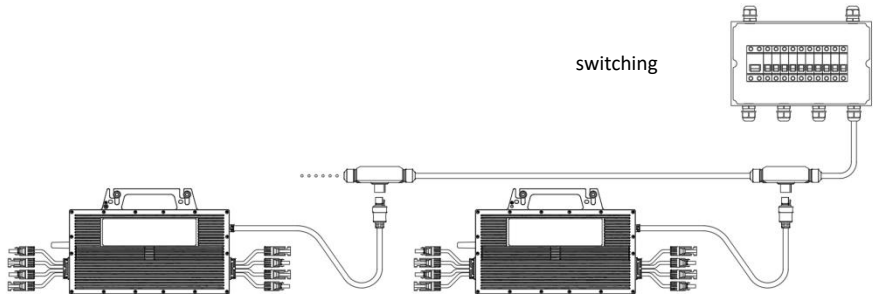
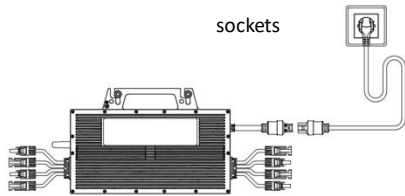

Step 5 - Create Installation Diagram

- A) Peel off the removable label and attach the label to the corresponding position of the microinverter.
- B) Depending on the location of the microinverter in the overall system, attach the appropriate label to the installation diagram.

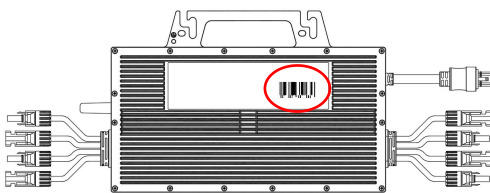

		To: 12.4.2016						
Name of the device	Phase	Phase Group		Phase		Status		
		1	2	3	4	5	6	
1								
2								
3								
4								
5								
6								
7								
8								
9								
10								
11								
12								

Step 6 - Connecting the PV Module

- A) Installation of photovoltaic modules.
- B) Connect the DC cable from the PV module to the DC input port of the microinverter.

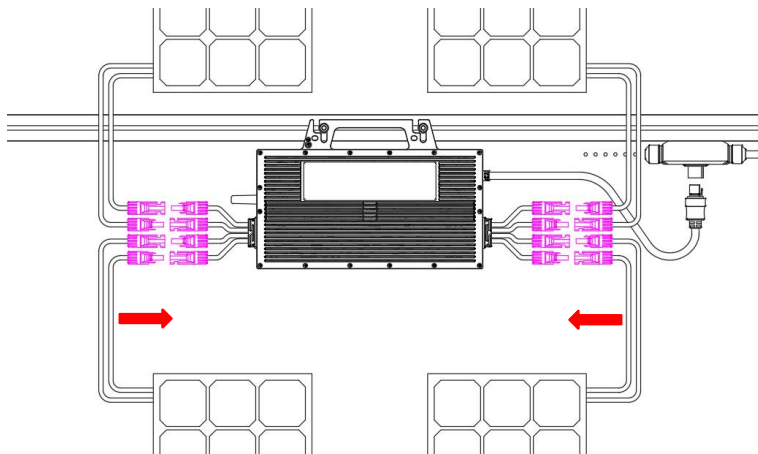

* The DC cable of one PV module must be connected to the DC input port on the same side of the microinverter.

* The power of the PV module should meet the input requirements of the microinverter, please refer to the data sheet.

Step 7 - Powering Up the System

- A) Turn on the AC circuit breaker for the branch circuit.
- B) Turn on the house's main AC circuit breaker and the system will begin generating power in approximately two minutes.

6. APP

6.1 Download APP

The app allows you to remotely monitor and adjust the microinverter.

Search for "Smart Life" in the Apple App Store and other major app stores, or scan the QR code below to download the "Smart Life" APP.



6.2 Register an account

1. Click Sign Up to read and agree to the User Agreement and Privacy Policy and go to the Register page.
2. Register an account with an e-mail address or a cell phone number. the State/Region is specified automatically and can be changed manually. However, the value of this field cannot be changed after registering an account. click Get Verification Code.
3. Enter the verification code you received and go to the password setting page, set the password as

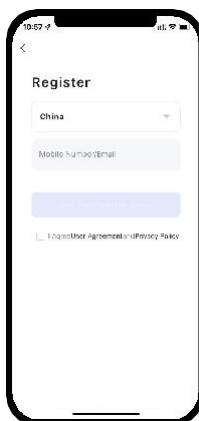
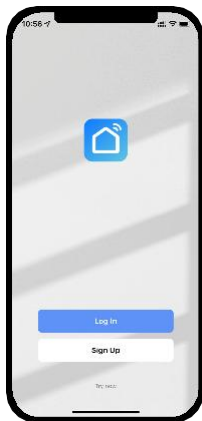

required and click Done.

6.3 Connecting the microinverter

1. Allowed to go into distribution mode within 3 minutes of powering up, AC plugged and unplugged three times within 20s to start distribution.
2. Open the Smart Life APP, the Microinverter Add button will pop up automatically, click Add to start connecting the microinverter. If the Microinverter Add button does not pop up automatically, you need to manually click the Add Device button to search for nearby devices and enter into the distribution mode.
3. Follow the prompts to enter your Wi-Fi account and password, click the Next button when finished, and wait a few minutes for the microinverter to finish dispensing.

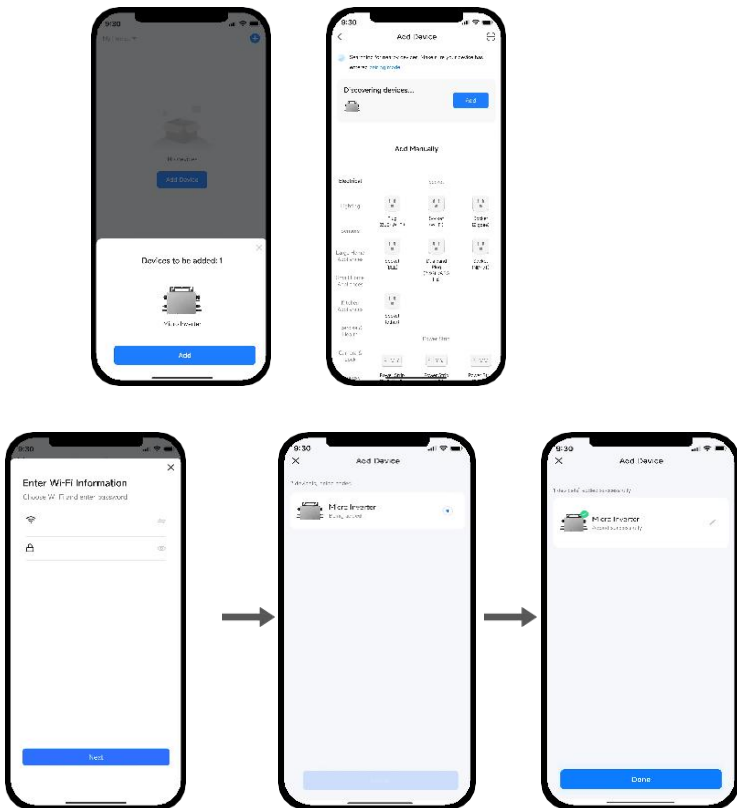

6.4 APP interface

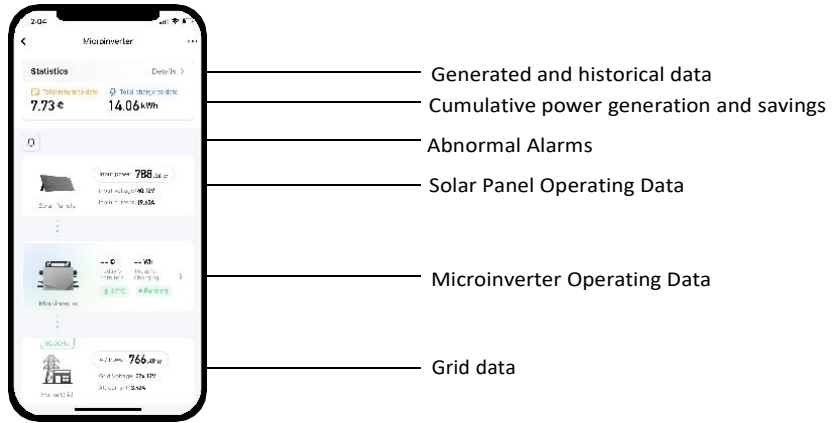

1. Click Details to view generated and historical generated data

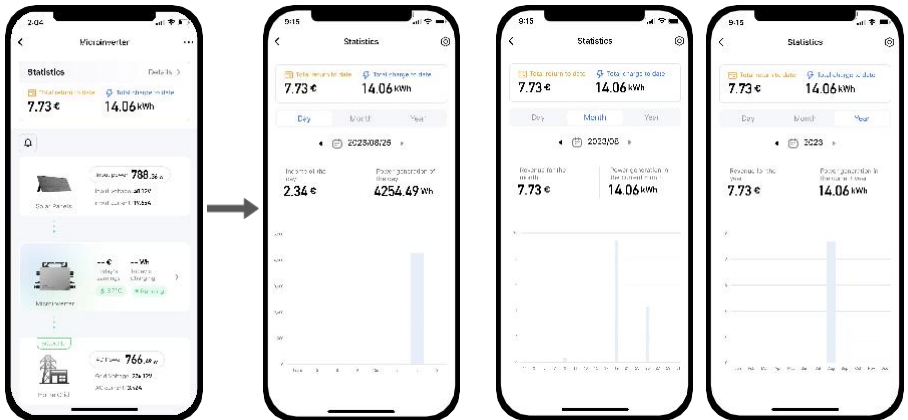

2. Click the Setup button in the upper right corner to access the Rate Setup screen to set the currency and power unit price.

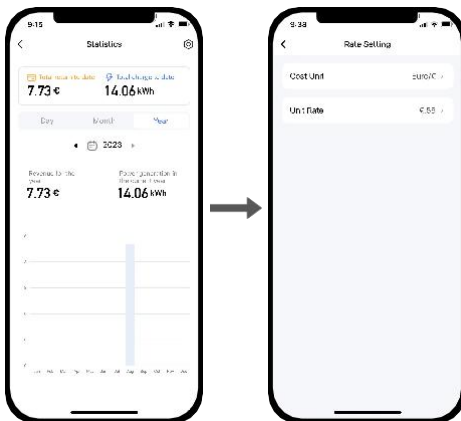

7. fault resolution

7.1 LED status indication

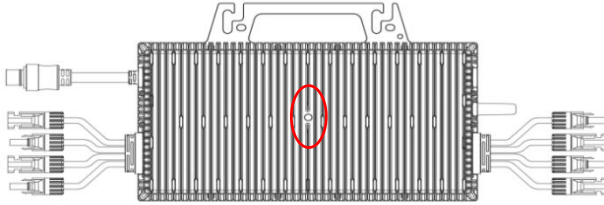

Red light always on	Check APP alarm information
Green light flashing	Not connected to WiFi, running normally, automatically tracking the maximum power of PV
Green light always on	Connected to WiFi, running normally, automatically tracking maximum PV power
The light is not working	PV has no input voltage or internal fault

7.2 APP alarm information

	APP alarm information
1	PV high-voltage protection
2	PV low-voltage protection
3	WiFi not connected
4	High temperature reminder
5	High temperature protection
6	AC low-frequency protection
7	AC high-frequency protection
8	AC high-voltage protection
9	AC low-voltage protection
10	AC power outage
11	Island protection
12	AC not connected
13	Relay fault
14	AC ground fault
15	PV ISO fault
16	Auxiliary Power fault
17	Internal Communication fault
18	PVA no current fault
19	PVB no current fault

7.3 Replacement of microinverters

Follow these steps to replace the microinverter

- a) Turn off the branch circuit breaker and disconnect AC power.
- b) Disconnect the AC connector from the microinverter.
- c) Cover the PV module with an opaque cover to ensure that there is no current in the wires between the PV module and the microinverter.
- d) Disconnect the PV module connector from the microinverter.
- e) Remove the microinverter from the PV mount.
- f) The microinverter to be replaced is mounted to the PV mount.
- g) Remove the shade cover from the PV module.
- h) Connect the PV module connector on the microinverter.
- i) Connect the AC cable on the microinverter to verify that the microinverter is working properly.

* :: The inverter must be replaced by a trained professional.

* :: The DC operating voltage range of the photovoltaic module must match the allowable input voltage range of the microinverter.

8. Data sheet

Model number	NBQ1600-EU	NBQ2000-EU	NBQ2250-EU	NBQ2400-EU
Input parameters (DC)				
Recommended Solar Panel Input Power	275-430W×4	275-530W×4	275-625W×4	275-650W×4
Number of DC input connections	MC4 × 4			
Maximum Input Voltage	60V			
Max input short-circuit current	25A*4			
DC voltage input range	16-60V			
starting voltage	22V			
Maximum power point tracking voltage range	22-55V			
MPPT tracking accuracy	>99.5%			
Maximum input DC current	14A*4	16A*4	18A*4	18A*4
Output parameters (AC)				
Maximum output power	1600W	2000W	2250W	2400W
Rated output voltage	230V			
AC Voltage Range	190-270V			
Rated output current	6.95A	8.69A	9.78A	10.43A
Rated output frequency	50Hz/60Hz			
Output frequency range	47.5-51.5 Hz/57.5-62.5 Hz			
Harmonic distortion	<5%			
Output power factor	>0.99			
Maximum conversion efficiency	96%			
Protection level	Class I			
Protective function				

Overvoltage/undervoltage protection	YES
Over-frequency/ under-frequency protection	YES
Anti-islanding effect protection	YES
Over current protection	YES
Overload protection	YES
Overtemperature protection	YES
Protection class	IP67
Operating Temperature Range	-40°C to +65°C
Indicator light	Working status light: LED light
Communication mode	Wi-Fi / 2.4G
Cooling method	Natural cooling (no fan)
Working environment	Indoor/Outdoor
Weights	5.2kg
Size(L*W*H)mm	342mm*225.4mm*50mm
Standards-compliant	EN62109 EN61000 EN62920 Ordinance NO.140 Rohs: IEC62321

9. attachment (email)

9.1 Annex 1 Installation map

Please make N for north	Panel Group. Azimuth. Sheet__of__		Customer:		Installer.							
	1	2	3	4	5	6						
a												
b												
c												
d												
e												
f												
g												
h												
i												

9.2 Annex 2 Wiring diagram

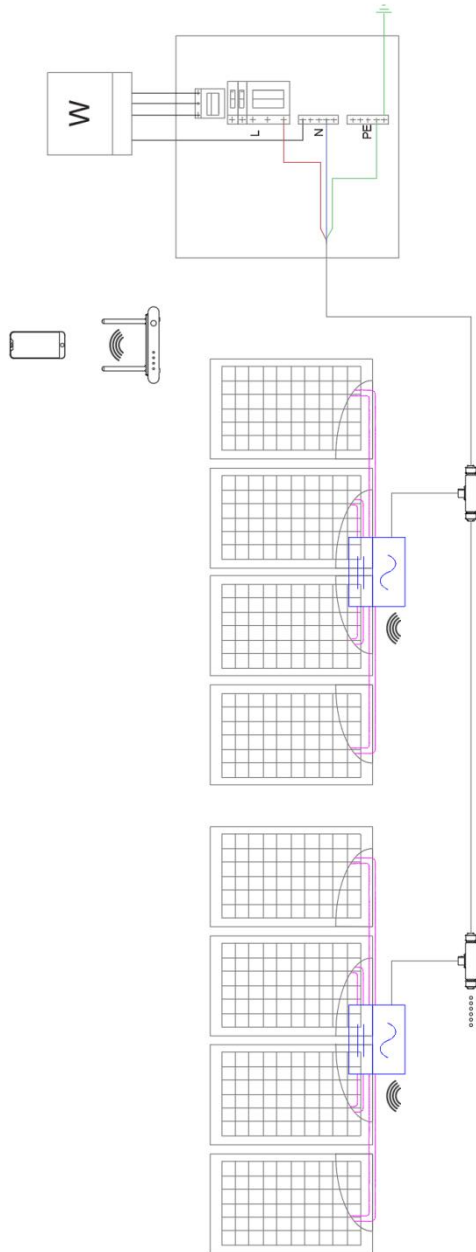

614-00014-02